

**PRACTICAL  
SHOTGUN  
COURSE  
SUPPLEMENT**



PREPARED  
BY



**HIGH STANDARD MANUFACTURING CORPORATION**  
HAMDEN, CONNECTICUT

## THE HIGH STANDARD MANUFACTURING CORPORATION



MANUFACTURERS OF "HIGH STANDARD" SPORTING FIREARMS  
1817 DIXWELL AVENUE · HAMDEN, CONN. 06514

### AN OPEN LETTER TO POLICE OFFICERS:

In the last few years, I have urged our Research & Development and Engineering Departments to design a riot-gun for the exclusive use of law enforcement officers. Such a gun is now a reality.

While our new riot-gun was being developed, I asked our people to come up with a shotgun training course that would be practical, economical, challenging and, above all, useful in learning to handle a riot-gun. A Practical Shotgun Course presented in booklet form is, also, now a reality.

After reviewing the PSC booklet, I felt several things had been left out. It seemed to me we should tell policemen about the many accessory products that can be used with a riot-gun to make it an even more effective and formidable weapon.

That is how the PSC Supplement came into existence. It contains a lot of good information gathered from many sources. There was no intent to leave out any manufacturer or his products. There is, undoubtedly, more that could be said and shown in this Supplement --- but it was not meant to be a catalog so the line had to be drawn.

I sincerely hope you find these two booklets informative. Please call on me if I can be of further service to you or your department.

Sincerely,

William J. Donovan  
Vice President Marketing

# 3 IMPORTANT REASONS

why **HIGH STANDARD** produces the best Riot Gun!

High Standard riot-guns are built for tough and rugged duty. No other guns made will withstand more punishment, more adverse conditions of weather or emergency. From the hip or from the shoulder, a High Standard will provide maximum striking power and pattern control loaded with shotshells. Loaded with rifled slugs, a High Standard shoots with consistent pinpoint accuracy and maximum penetration.



## 1 MORE FIRE POWER

Six in the magazine tube and one in the chamber for 7 fast shots make the High Standard Models 8111 & 8113 the riot-guns with the most firepower on the market today! Available in the new 18" barrel, with or without rifle sights, High Standard's extended magazine tube provides that extra shot that can often times mean the difference between life and death.



## 2 SMOOTHEST FREE FALLING ACTION

A free falling, dependable, pump action with a smooth 3½" stroke makes a High Standard riot-gun ideal for police use. An automatic disconnector on this pump action prevents hammer follow on the return-to-battery stroke. Safety-wise, this automatic disconnector makes it impossible for the gun to fire when racking another round into the chamber with the trigger depressed.

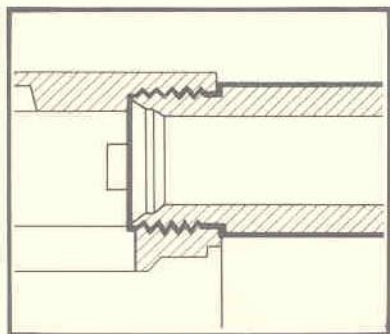

## 3 LOK-ALIGNED BARREL

Unlike other shotguns, the High Standard riot-gun is always instantly available for use. This gun cannot be taken down. Since no assembling is necessary, it can be brought into immediate action anytime — anywhere. The Lok-Aligned barrel to receiver principle assures consistent accuracy with instantaneous availability through precise and positive alignment of the barrel and receiver. More than 150,000 test rounds fired through one High Standard riot-gun proves the barrel will not and cannot shoot loose from the receiver. The Lok-Aligned barrel to receiver principle is one reason why a single action bar is all that is required on this modern police riot-gun as designed by High Standard.

## TAKE YOUR CHOICE OF RANGE, POWER AND PATTERN with a broad selection of loads.

Effective and efficient firepower aptly describe the use of high-performance rifled slugs. Today's high base rifled slugs are made with plastic bodies that are waterproof, swellproof and scuffproof. They chamber even after countless loadings and unloadings.



12 gauge rifled slugs leave the gun muzzle at 1600 feet per second with an energy of more than 2400 foot pounds. That's approximately 1¼ tons of energy. Extensive tests have shown that rifled slugs have the force to put cars out of action.

Fired from 25 - 30 yard ranges, slugs will rip through automobile bodies. A hit on any part of a car's ignition or carburetion system will literally demolish these necessary car parts. Any hit involving the braking or steering mechanism is a sure way to stop the vehicle. When fired into the engine block, rifled slugs can crack the iron or aluminum, destroying the cooling system to assure quick and sure stopping of the car.

### BALLISTICS OF RIFLED SLUGS

Velocity in feet per second at:













MUZZLE	25 YARDS	50 YARDS	100 YARDS
1600	1365	1175	950
Energy in Ft. lbs. 2485	1810	1340	875
Drop in inches:	.5	2.1	10.4

No. 2 shot travels about 330 yards. 00 Buck travels about 610 yards. These are maximum travel distances. Useful and effective pattern density is less than the maximum travel distance.

The 00 Buck load, with 9 pellets, is the safest where the possibility of hitting innocent bystanders is involved. The spread of 00 Buck pellets can be figured at about 1 inch or less per yard of range. At 20 yards of range, all pellets will be well within a 20 inch diameter circle. (This rate of spread applies just to ranges under 50 yards.) "Bounce" or deflected shots with No. 6, No. 4, or No. 2 shot will produce an excellent dispersion of energy before hitting the target. The reason is — the pellets are smaller and lighter.

Riot Gun shotshells — in addition to rifled slugs described above — come in a variety of shot sizes. They do an effective shooting job under any conditions. It is possible to fire from 9 to 700 pellets toward the target. Effective ranges are determined by pellet count.

### 12 GAUGE RIOT GUN LOADS

ACTUAL SIZE				
SIZE	00 Buck*	00 Buck	0 Buck	1 Buck
PELLETS PER LOAD	12	9	12	16
ACTUAL SIZE				
SIZE	4 Buck	BB Shot	2 Shot	4 Shot
PELLETS PER LOAD	27	63	110	170
ACTUAL SIZE				
SIZE	5 Shot	6 Shot	7½ Shot	9 Shot
PELLETS PER LOAD	215	278	437	730

\*Standard 2¾" length Magnum load.

## POSITIVE SHOTGUN PROTECTION IN POLICE CARS

Police problems are daily more complex. A policeman on motor patrol is never quite certain where his next call will take him or what the situation will be when he arrives. For that reason, modern squad cars carry just about every conceivable piece of equipment that might be required to do the job under any circumstance. The shotgun is one of those necessary pieces of equipment found in a police car.

The riot-gun may never be used for anything other than to flush a suspected felon out of a dark alley. (The unmistakable sound of a pump action chambering a shell in a riot-gun is many times all that is required to make a suspect give up without a fight.) Yet, if the need to fire the riot-gun arises, the officer can be sure he will hit and at least disable his adversary.

The problem of carrying a shotgun in a squad car and securing it from the hands of others is a difficult problem. Some police cars are equipped with shotguns sheathed in a scabbard fitted to either front door, or slung along the front side of the front seat. Although these methods of carrying make the riot-gun instantly available, they do not insure complete security of the gun.

Shown below are two devices available to law enforcement agencies that do a good job of securing the riot-gun in a police car.



### LEKTRO LOK SHOTGUN HOLDER

This High Standard riot-gun is securely under control of the driver. There are no keys to lose, break, or key lock to malfunction. LEKTRO LOK automatically locks when closed.

LEKTRO LOK can be purchased complete with lock mounting bracket, butt holder, wires, releasing button and instructions. For further information, write to:

GEORGE F. CAKE COMPANY  
P. O. BOX 649  
BERKELEY, CALIFORNIA

### FLETCHER GUN HOLDER

This holder protects a High Standard riot-gun when the police car is left unattended—the positive key locking feature and rugged construction eliminates “jumper wire” release or “locked-in” gun if the electrical system fails. Quick finger-tip release lets either the driver or his partner have the gun ready for use in seconds. For further information write:

F. MORTON PITT COMPANY  
1444 SOUTH SAN GABRIEL BOULEVARD  
SAN GABRIEL, CALIFORNIA

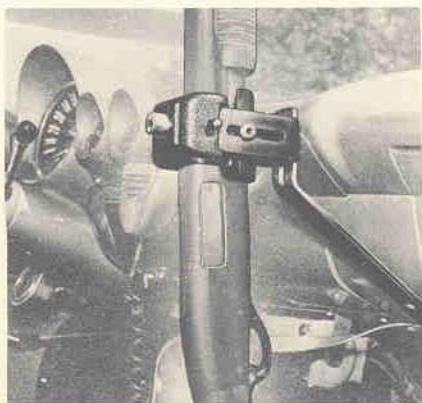

# AAI MULTI-PURPOSE GRENADE



## RIOT SHOTGUN LAUNCHER

This launcher can be quickly and easily installed on the muzzle of a High Standard Model 8104 12 gauge riot-gun. Alterations or the placement of barrel inserts in the gun are not necessary. Recoil is similar to that of a 12 gauge shotshell. Accuracy for ranges up to 120 yards is possible.

## MULTI-PURPOSE GRENADE

This unique grenade is made of injection molded plastic and can be purchased loaded with CN, CS, Dye, Liquids, Smoke, Powders or a combination of Chemicals. The teeth like projections, usable at the base of the grenade, engage in the rifling of the Riot Shotgun Launcher (shown above) to produce greater accuracy.



## SELECTIVE TIME DELAY FUSE

An important feature of the Multi-Purpose Grenade is an adjustable, selective system of time delay fuses. The police officer has a choice of instantaneous, 2-second or 5-second delay action before the grenade charge is delivered. This feature (shown at the right) provides tactical flexibility in the use of the grenade.

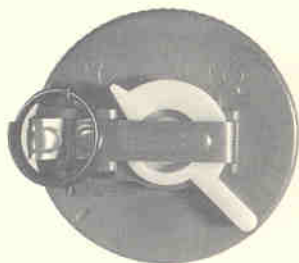

## LAUNCHER CARTRIDGE

The launcher cartridge (shown at the left) contains **smokeless powder**. It produces enough energy to propel the multi-purpose grenade up to 120 yards. The inherent design of this cartridge produces a minimum amount of corrosive residue as compared with black powder blank rounds.



Shown above is a High Standard Model 8104, 20" barrel, 6 shot 12 gauge riot-gun with a Riot Shotgun Launcher, Multi-Purpose Grenade. Below the breech and in front of the trigger guard is the Launcher Cartridge.

For additional information write:



**AIRCRAFT ARMAMENTS, Inc.**  
COCKEYSVILLE, MARYLAND

# RIOT CONTROL DEVICES

## INSTANTLY ATTACHED

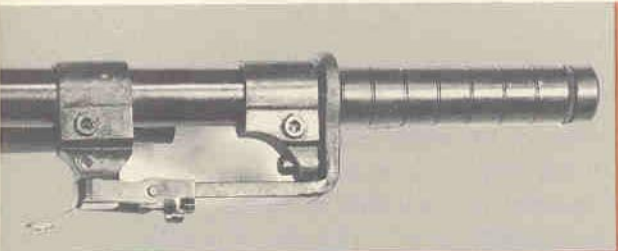

The SERVICE ARMAMENT Model D Grenade Launcher attaches to a shotgun, with a hand guard unit previously installed, in a matter of five seconds converting a High Standard Model 8104 12 gauge riot-gun to a potent grenade launching firearm.

## READY FOR COMBAT IN 15 SECONDS



Fifteen seconds is the time it takes to select the proper missile, desired range and fire — SERVICE ARMAMENT'S Model D Grenade Launcher.

## CONVERTS RAPIDLY FOR CLOSE COMBAT



As fast as it is attached the grenade launcher can be removed and the new self-sharpening bayonet can be snapped into position on the barrel.

## THE NEW SERVICE GRENADE



The new SERVICE ARMAMENT Grenade is a burning type tear gas grenade custom made for shotgun launching with ranges from 10 to 150 yards utilizing a special 12 gauge grenade launching cartridge.

## U.S. COMBAT BAYONET



SERVICE ARMAMENT also can provide the now famous U. S. combat self-sharpening bayonet — the finest military bayonet available anywhere in the world.

For further information write:

SERVICE ARMAMENT COMPANY 689 BERGEN BOULEVARD  
RIDGEFIELD, NEW JERSEY



Penguin's Muzzle Dispersion, Tear Gas Cartridges, Long Range Cartridges, Signal Flare Cartridges and Long Range Grenades make the 12 gauge riot-gun a more flexible police tool.



### LONG RANGE TEAR GAS GRENADE

No adapters or attachments are required. The long range grenade unit consists of: the grenade, the launching rod, (which separates from the grenade on launching) and a non-corrosive propellant cartridge. 128 gms. of burning type CN are contained in the grenade. Ranges up to 150 yards are possible with minimum recoil to the shooter.



### LONG & SHORT RANGE TEAR GAS CARTRIDGES

12 gauge tear gas cartridges make it possible to equip all riot guns with a low-cost, highly efficient, burning type tear gas projectile. Long range tear gas cartridges project a light weight-vented-projectile dispensing a large volume of tear gas smoke up to 150 yards in range. Muzzle dispersion tear gas cartridges deliver a short range blast of Penguin's new, powerful CN/X5 micro-sized tear gas powder. All cartridges are high base, with color coded plastic bodies for quick identification.



### SIGNAL FLARE CARTRIDGES

Signal Flare 12 gauge cartridges may now be used as a signaling device on stake-outs or raids. Penguin's Signal Flare 12 gauge cartridges fire a single 8000 candle power (minimum) Red Star approximately 300 feet in the air, burning 5 to 6 seconds. Nine types of signal flare cartridges are available. The cartridges are low base, with plastic body and color coded red.

FOR FURTHER INFORMATION WRITE:  
**PENGUIN ASSOCIATES, INC. MALVERN, PENNSYLVANIA**